

LED Shaving- and cosmetic mirror, round, wall mounted, two swivel arms with helix cable and switch 5 magnifying glass

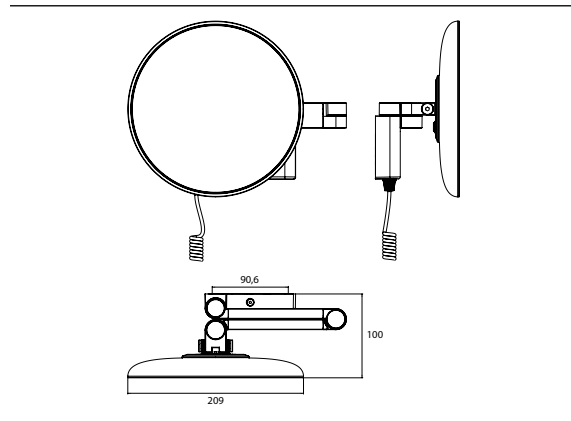

Art.No.1095 060 40

2 switches (brightness and luminous colour cold/warm continuously dimmable), energy efficiency grade: A - A++