

## 1.

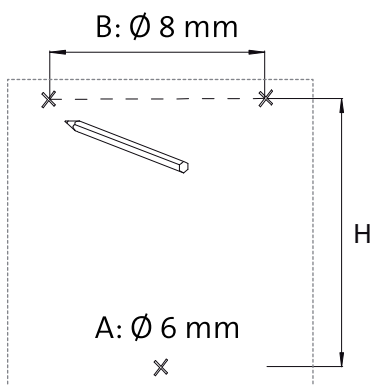

Art.	B	H
4496 000 80	460	780 mm
4496 000 81	660	680 mm
4496 000 82	860	680 mm
4496 000 83	1060	680 mm
4496 000 84	438	540 mm
4496 000 85	638	540 mm
4496 000 86	838	540 mm
4496 000 87	1038	540 mm
4496 000 88	638	540 mm
4496 000 89	838	540 mm
4496 000 90	1038	540 mm

## 2. × B: Ø 8 mm

2.1

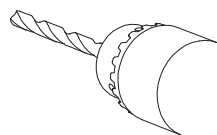

2.2

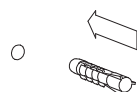

2.2

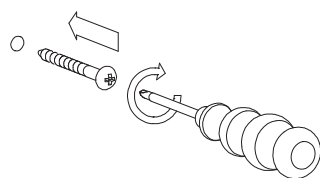

2.4

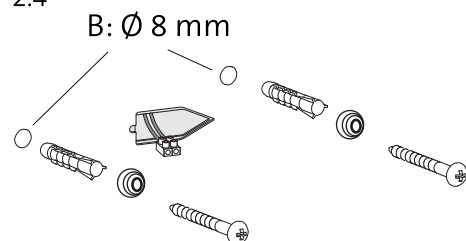

A: Ø 6 mm

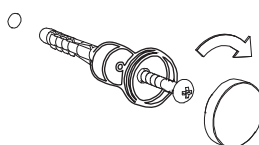

## 3.

3.1

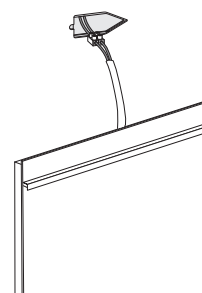

3.2

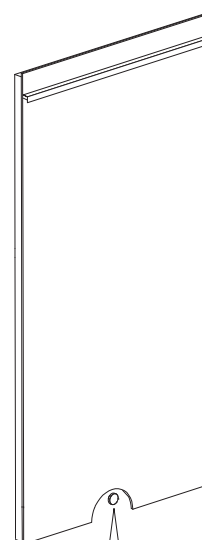

3.3

3.4

3.5

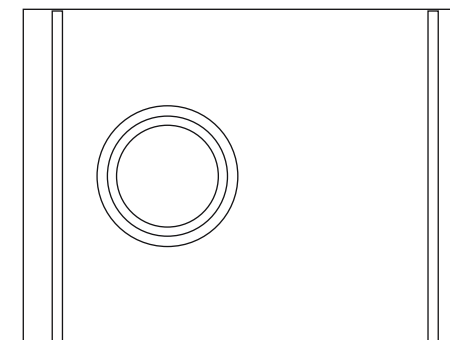

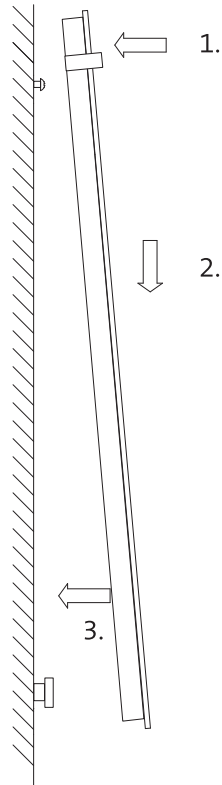
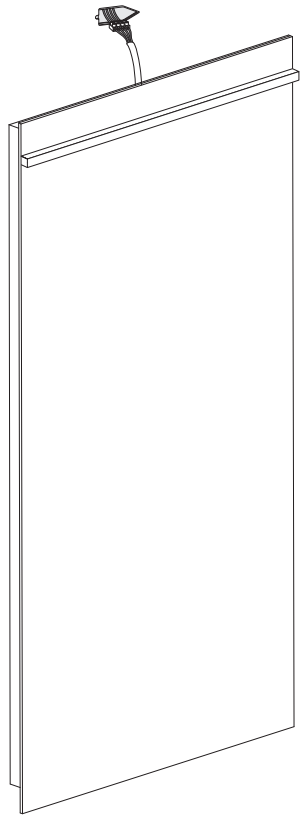

## DE

Betriebsspannung: 100-240V~ 50/60Hz  
Die Montage darf nur durch eine Elektrofachkraft entsprechend der VDE 0100, Teil 0701 erfolgen.

## GB

Operating voltage: 100-240V~ 50/60Hz  
Installation may only be effected by a qualified electrician in accordance with VDE 0100, Part 0701.

## FR

Tense de service: 100-240V~ 50/60Hz  
Uniquement un électricien est autorisé à effectuer le montage conformément à la norme VDE 0100, partie 0701.

## NL

Bedrijfsspanning: 100-240V~ 50/60Hz  
De montage mag alleen worden uitgevoerd door een elektromonteur overeenkomstig VDE 0100, deel 0701.

**ACHTUNG:** Das beigefügte, universelle Befestigungsmaterial ist nicht für alle Untergründe geeignet. Bitte verwenden Sie nur - für den jeweiligen Untergrund - geeignete Schrauben und Dübel. Bitte prüfen Sie deshalb vor der Verwendung sorgfältig, ob das beigefügte Befestigungsmaterial für den jeweils vorgesehenen Untergrund tauglich ist.

**CAUTION:** The universal fastening accessories supplied with the product are not suitable for all substrates. Please only use screws and plugs that are suitable for the substrate concerned. Therefore, before using the accessories, please carry out a thorough check to ensure that the fastening accessories supplied with the product are suitable for the intended substrate.

**ATTENTION:** le matériel de fixation universel fourni ne convient pas à tous les supports. Veuillez utiliser uniquement les vis et les chevilles appropriées au support respectif. C'est pourquoi, nous vous prions de vérifier soigneusement avant toute utilisation si le matériel de fixation fourni est compatible avec le support prévu.

**OPGELET!** Het bijgeleverde, universele bevestigingsmateriaal is niet geschikt voor alle ondergronden. Gebruik alleen schroeven en pluggen die geschikt zijn voor de betreffende ondergrond. Controleer daarom a.u.b. vóór gebruik zorgvuldig of het bijgeleverde bevestigingsmateriaal geschikt is voor de bestaande ondergrond.

